



ENDURANCE® 
Solid & Secure Composite Doors

**PROTECT YOUR HOME WITH A
SOLID AND SECURE DOOR**

endurancedoors.co.uk



Safety, Security & Style.

It all starts with an

Endurance Door.

Renowned for their strength and security, an Endurance Door means you'll enjoy peace of mind every time you turn your key.

The 48mm thick solid timber core of an Endurance Door is up to 10% thicker than other doors on the market, a difference you'll hear each time you close your door. Whilst other doors may click shut, the reassuring clunk of an Endurance Door lets you know that your home is both safe and secure.

Each Endurance Door has a host of unique features that make it the most durable and hard-wearing door available. Designed to stand the test of time, your Endurance Door will require very little maintenance to keep it looking great for years to come.

Use our innovative HomeView Door Designer to try our range of door styles, colours, glazing and hardware accessories on a photo of your own home.

endurancedoors.co.uk

Contents

<p>Why Choose Endurance? p.4-5</p>	<p>Security Options p.6-7</p>	<p>Our Colours p.8-9</p>	<p>Homeview Door Designer p.10</p>	<p>Preferred Installer Network p.11</p>
<p>The Classic Collection p.12-35</p>	<p>The Country Collection p.36-61</p>	<p>The Urban Collection p.62-77</p>	<p>French Doors p.78-79</p>	<p>Stable Doors p.80-81</p>
<p>Side Panels and Toplights p.82-84</p>	<p>Glazing Options p.84-96</p>	<p>Hardware p.97-101 Accessories</p>	<p>Ultion Smart p.102-103</p>	<p>Our Green Promise p.105</p>

Why Choose Endurance?

Safety, Security & Style.



✓ Your Door. Your Style

With over 85 stylish door designs, 19 colours and an amazing choice of glazing and hardware accessories within our range, you're sure to find the ideal fit for your home. Let our brochure be your source of inspiration before heading over to our online HomeView Door Designer.

✓ Solid to the Core

The core of an Endurance Door is made up of 17 crossed layers of engineered timber, giving them unrivalled strength and a reassuring feel of quality.

Choose an Endurance Door to make would-be burglars think twice.

✓ Built to Last

Every Endurance Door is made with an integrated Moisture Barrier Strip at the foot of the door. This unique feature means that the timber core of an Endurance Door is protected from water ingress, removing the risk of swelling or sticking.

✓ Secured By Design

Secured By Design is the official UK Police initiative supporting the principles of 'designing out crime'. The Endurance Door design achieves this standard when combined with laminated glass and the 3 Star High Security Federal UCF locking cylinder.

In order to meet this standard the Endurance Door range has been put through a series of rigorous tests, designed to replicate methods a burglar might use to gain entry to your home. Including:

- A manual attack on the locking hardware, including a crow bar and mole grips
- Unlimited number of 3 minute attacks on the door cylinder using a range of tools such as screwdrivers and craft knives
- 3 minute manual attack using chisels and brick bolsters to gain entry through the door
- Hard Impact Test - The door is struck with a 50kg steel impactor at its hinge and locking points



SLEDGEHAMMER-PROOF

We put the Endurance Door design to the test by attacking it with a sledgehammer.

Scan the above code with the camera on your Smartphone to see how we got on!

Locking Cylinder

Our standard locking cylinder is anti-pick, drill and bump with a sacrificial cut included with our High Security Upgrade

High Security Multi-point Locking System

Our locking systems are tested to Secured By Design specified PAS 24 Security Standards

Solid Timber Core

48mm thick cross laminated solid timber core makes the Endurance Door the most solid and secure on the market

Moisture Barrier Strip

Our unique moisture barrier strip is concealed within the foot of the door - preventing the Endurance Door from warping or swelling

Hardware Accessories

Our Hardware Accessories have been rigorously tested to ensure their durability - so you can count on them to look great for years to come

Hard Wearing Door Skin

CoolSkin® technology used to produce our door skins offers a realistic woodgrain texture whilst protecting against delamination, cracking, bowing or warping

PVCu Door Frame

Our door frames are strong, secure and energy efficient. They are even made from environmentally friendly recycled plastic

Thermally Toughened Glazing

Our range of stylish decorative glazing has been thermally toughened, offering the best in security whilst also looking beautiful



The UK's Most Solid & Secure Composite Door



FEDERAL UCF Cylinder ★★ ★

At Endurance Doors, we believe everyone has the right to feel safe and secure in their own home.

That's why our doors can be upgraded with the Federal UCF Locking Cylinder from Brisant, one of the most secure locking cylinders in the UK.

The clever locking system of the Federal UCF knows when it's being attacked, with a hidden locking mechanism that automatically engages to stop would-be burglars in their tracks.

Lock snapping has become the preferred entry method for UK criminals and the Federal UCF Locking Cylinder has another trick up its sleeve to keep burglars at bay. A sacrificial cut is used so that when the burglar grabs the end of the cylinder, just the tip snaps off, leaving more metal in front of the central locking mechanism as protection.

Having been tested to Sold Secure 'Diamond Grade' standards, the Federal UCF Locking Cylinder has achieved a level of security that far surpasses other locking cylinders on the market.



Locking Options



Our range of Locking Mechanisms offer an exceptional degree of security, meaning you can relax knowing your home is protected by some of the most tried and tested locking technology available.

Trulock+

A modern-day locking system with two tensile steel hooks and a centrally located deadbolt.

Ideally suited to doors with Lever/Lever or Lever/Pad handles. Lift the handle to engage the locking mechanism and lock with a key.

AV2 Automatic Lock

This locking mechanism automatically locks once the door is slammed shut, with firing pins engaging the two tensile steel hooks. The deadbolt is then activated by turning the key.

The door can then be opened internally using a thumbturn cylinder, but remains completely secure from the outside.

Ideal for doors with fixed external handles. Once locked, entry from outside is gained by use of a key.

AV3 Automatic Lock

The AV3 Locking mechanism has a magnetic trigger in its frame that causes two tensile steel hooks and two separate weather sealing elements to fire automatically once the door is slammed shut.

An optional daytime release function can be integrated to temporarily stop the door from automatically locking once closed.

Ideal for doors with fixed external handles. Once locked, entry from outside is gained by use of a key.

Locking Cylinder Positioning



Standard Position

The standard locking position of the Trulock+, AV2 and AV3 is mid-way down the door.



Heritage Position

The AV2 and AV3 Automatic Locking Mechanisms are available in a Heritage variation. This locking position is ideal for bringing a traditional feel to your entrance and can be combined with any of our fixed handle options.

SNAP SECURE



ANTI-BUMP



ANTI-DRILL



ANTI-PICK



£1000

SECURITY GUARANTEE

We are so confident in the unprecedented level of security offered by the Federal UCF Locking Cylinder used in our doors, that in the unfortunate event your home is broken into by means of snapping the cylinder, we will offer £1,000 in compensation.

Terms & conditions apply. See website for full details.

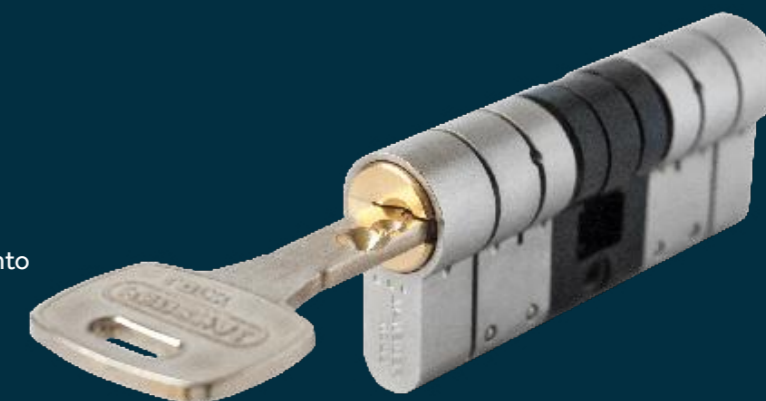

Your Choice, Your Colour

Endurance Doors are available in your choice of 19 different colours, with the option to choose an alternative colour for the exterior and interior of your door. Most of our customers choose a white internal finish, but with so many different colours available the choice is yours.

We're also able offer perfectly matching door frames for most of our door colours too.

*Not available as a matching coloured frame. For doors of this colour we recommend a white or cream frame.



White

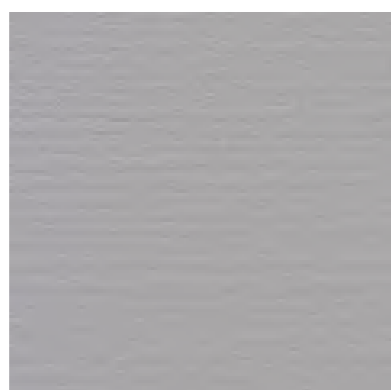

Pearl Grey



Elephant Grey



Anthracite Grey

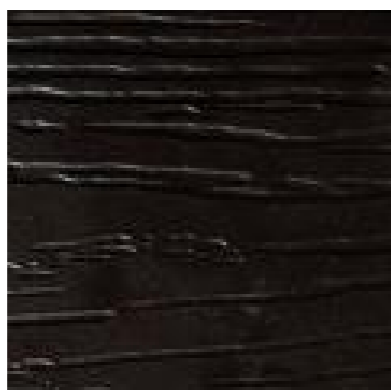

Schwarz Braun

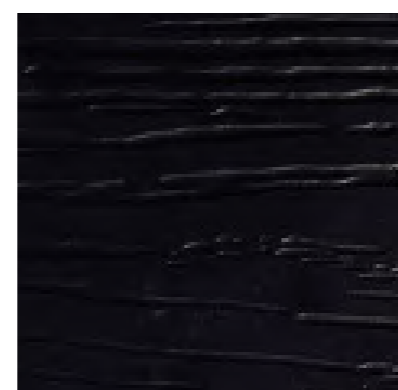

Raven Black

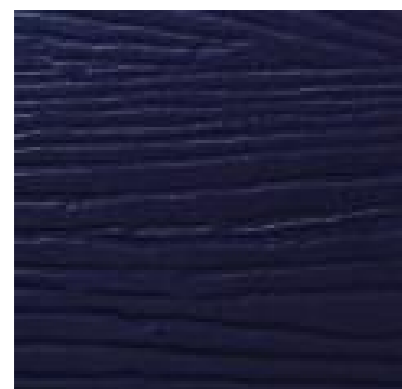

French Navy



Duck Egg*



Turquoise Pastel*

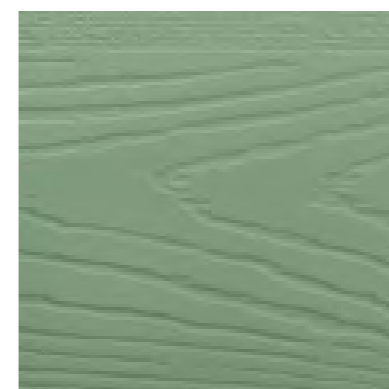

Chartwell Green



Racing Green



Pebble*

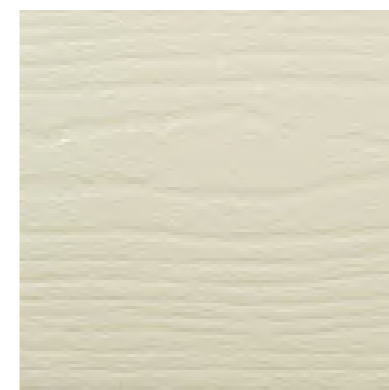

Cream



Rich Red

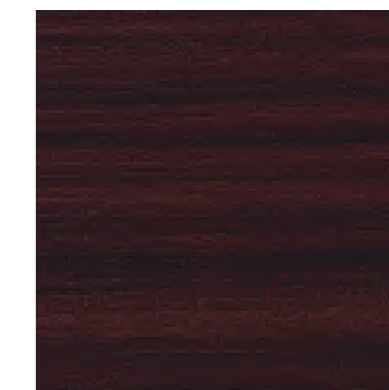

Mahogany

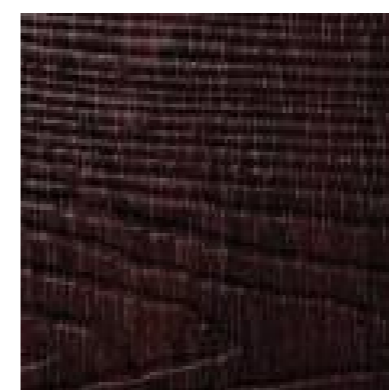

Rosewood

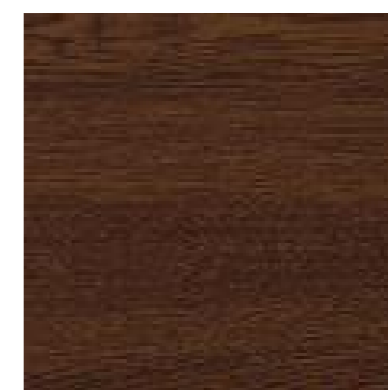

Walnut

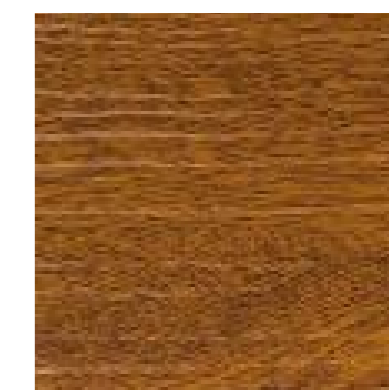

Golden Oak

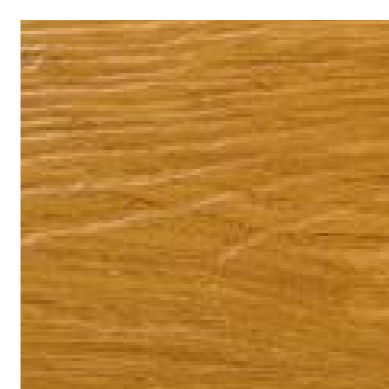

Irish Oak

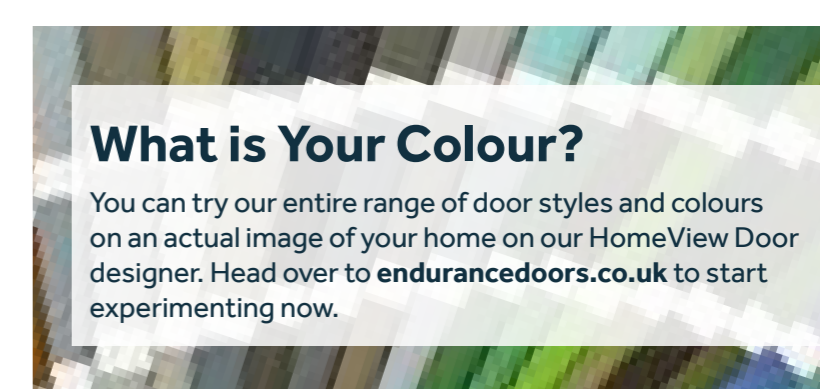

Design the Door of your Dreams

ENDURANCE
PREFERRED INSTALLER

You're in safe hands with our Preferred Installer Network

Take the guess work out of creating your dream entrance with our innovative HomeView Door Designer.

Take a picture of your home and you'll be able to try our full range of different door designs, colours and glazing options to create a realistic vision of your finished entrance.



We only select the most talented installers to join our Preferred Installer Network, so you can be sure your Endurance door will be installed to the highest possible standard.

All of our Preferred Installers have full access to not only the most solid and secure composite doors in the UK, but to our knowledge and expertise too. With one of our Preferred Installers, you can be sure of the best advice on choosing the right door for your home and the highest quality installation.

PREFERRED INSTALLER CHARTER

To ensure that our Preferred Installers reach our high standards they must meet the following criteria:

- Have a track record of installing Endurance Doors to our agreed fitting standard
- Have a clearly defined customer care policy that places the needs of the homeowner first
- Have clearly defined policies for monitoring service levels and handling complaints
- Have an excellent knowledge our products and are specialist Endurance Door installers



View our full range of door styles, colours, glazing and hardware accessories on our HomeView Door Designer

Visit endurancedoors.co.uk to find out more.



"I just love absolutely everything about my door."

From the style, the quality, the way the door has been fitted. It's just amazing."

- Karen



"The installation was such a smooth process. For a big job, it was done quickly and efficiently by people who knew what they were doing and were professional and friendly."

It was really easy!"

- Louise



"I would definitely recommend Endurance Doors to my family and friends. I have two of them at my current home and would definitely have them again at my next property."

- Mina



Get The Full Story

Hear more about what it's like to order an Endurance Door through a member of our Preferred Installer Network.

Scan this code with the camera on your Smartphone to learn more.



The *Classic* Collection



Our range of Classic door designs look fabulous when combined with some of our more intricate triple glazed glass designs. Combining detailed leaded shapes, bevels and varying textures, our triple glazed designs are a modern take on traditional glazing methods. Offering you the best in style whilst also being thermally efficient and secure.

The *Classic* Collection

Designs inspired by the Georgian and Victorian eras. If you're looking to add some classic character to your home, this collection is your range of choice. Our realistic woodgrain effect skins mean your new Endurance Door will look just like natural timber whilst being solid, secure and virtually maintenance free.



Ben Nevis
pg.16



Berwyn
pg.17



Bowmont
pg.18



Cheviot
pg.19



Eiger
pg.20



Elbrus
pg.21



Etna
pg.22



Hope
pg.23



Lingmell
pg.24



McKinley
pg.25



Mont Blanc
pg.26



Monte Rosa
pg.27



Olympus
pg.28



Pentland
pg.29



Scafell
pg.30



Skiddaw
pg.31



Snowdon
pg.32



Tate
pg.33



Walton
pg.34



Wentwood
pg.35

Ben Nevis

Inspired by the architectural approach of the Georgian age, the Ben Nevis offers total privacy and security for you and your family.



Anthracite Grey



Duck Egg



Golden Oak



Chartwell Green / Spring



Duck Egg / Satin



French Navy / Elizabeth Red



Pebble



Racing Green



Raven Black



Rich Red



Golden Oak / Opus



Pearl Grey / Sarah



Rich Red / Elizabeth Blue



Schwarz Braun / Murano Black

Berwyn

Let in natural light whilst still maintaining your privacy. The glazed area of the Berwyn allows this style to offer your home the best of both worlds.

Bowmont

A timeless classic. The Bowmont's large glazed areas lend this style to some of our more impressive and intricate glass designs.



Chartwell Green / Sarah



Golden Oak / Spring



Pearl Grey / Riviera



Anthracite Grey / Virtue



Cream / Spring



Duck Egg / Brilliance



Anthracite Grey / Clarence



Pebble / Virtue



Rich Red / Comete



Schwarz Braun / Fabian



Golden Oak / Graphite



Rich Red / Comete



Rosewood / Fabian



Schwarz Braun / Harmony

Cheviot

Fill your hallway with natural light and add instant kerb appeal to your home with the Cheviot design.

Eiger

If you're looking for a door that will bring a feeling of regency to your home, the Eiger and Eiger Georgian offer a distinguished appearance.



Anthracite Grey / Brilliance



Chartwell Green / Riviera



Duck Egg / Georgian



Chartwell Green / Spring



Anthracite Grey / Opal



Cream / Fabian



French Navy / Sarah



Pearl Grey / Spring



Racing Green / Virtue



Schwarz Braun / Georgian



Duck Egg / Diamonte



Elephant Grey / Riviera



Rich Red / Murano Blue



Schwarz Braun / Clarence

Elbrus

The generous glazed area of the Elbrus design allows natural light to fill the entrance of your home.

Etna

The most popular door style from our entire range, the Etna is the quintessential classic door design. Almost our full range of glazing designs are available in this style.



Anthracite Grey / Riviera



Duck Egg / Opus



Elephant Grey / Spring



French Navy / Opus



Duck Egg / Satin



Elephant Grey / Spring



Pearl Grey / Comete



Raven Black / Fabian



Rich Red / Clarence



Turquoise Pastel / Sarah



Cream / Murano Blue



Raven Black / Murano Black



Rich Red / Elizabeth Blue



Turquoise Pastel / Sarah

Hope

Create a sense of grandeur to your home by combining the Hope doorstyle with the leaded glass design Opus.

Lingmell

The classic Back door. The Lingmell design features a large glazed area, making it the ultimate choice for filling your home with natural light.



Rich Red / Harmony



Anthracite Grey / Satin



Chartwell Green / Riviera



Elephant Grey / Fabian



French Navy / Comete



Pearl Grey / Clarence



Walnut / Spring



Schwarz Braun



French Navy



Pearl Grey



Raven Black



Chartwell Green

McKinley

Solid, Secure and Stylish. The McKinley design offers a timeless appearance whilst delivering an unrivalled degree of privacy for your home.



Duck Egg



Elephant Grey

Mont Blanc

One of our most popular designs. The Mont Blanc lets natural light creep in whilst offering a level of security and privacy that all homeowners desire.



Golden Oak / Clarence



Anthracite Grey / Riviera



French Navy / Aspire Azure



Anthracite Grey / Riviera

Monte Rosa

A modern take on a classic design. The Monte Rosa can be paired with almost our entire range of stylish glazing options.



Chartwell Green / Spring



Duck Egg / Diamonte



Irish Oak / Spring



Pearl Grey / Comete



Racing Green / Murano Black



Raven Black / Harmony



Elephant Grey / Comete



Rich Red / Linear



Schwarz Braun / Adina



Walnut / Opal

Olympus

Typically ordered as a back door. The Olympus design's generously sized glazing area will ensure your home is filled with natural light.



Anthracite Grey / Adina



Duck Egg / Brilliance



French Navy / Diamonte



Elephant Grey / Harmony



Irish Oak / Graphite



Pearl Grey / Opal



Walnut / Elegance



Anthracite Grey

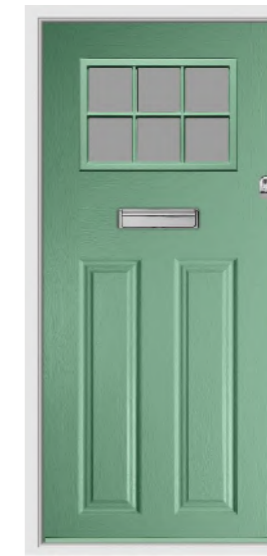

Chartwell Green



French Navy

Pentland

The Georgian glazing bars of the Pentland style give this design a truly sophisticated appearance.



Irish Oak



Pearl Grey



Pebble



Schwarz Braun

Scafell

Combine this style with any of our triple glazed glass designs to add a sense of drama to your home, without compromising on privacy.



Anthracite Grey / Graphite



Chartwell Green / Kerner



Elephant Grey / Sarah



Pearl Grey / Riviera



Pebble / Clarence



Schwarz Braun / Fabian



Walnut / Comete



Duck Egg / Riviera



Elephant Grey / Clarence



French Navy / Diamonte



Racing Green / Spring



Raven Black / Fabian



Rich Red / Georgian



Schwarz Braun / Virtue

Skiddaw

The glazing of the Skiddaw design lets in a generous amount of natural light, whilst still looking fabulously traditional.

Snowdon

Equally at home as a front or back door, the Snowdon design is one of our most popular. Choose Georgian bars to add a little rural charm to this classic design.



Rich Red / Harmony



Anthracite Grey / Georgian



Chartwell Green / Riviera



Anthracite Grey / Fabian



Chartwell Green / Riviera



Duck Egg / Harmony



Elephant Grey / Comete



French Navy / Spring



Racing Green / Georgian



Duck Egg / Clarence



French Navy / Diamonte



Rich Red / Clarence



Schwarz Braun / Deco



Turquoise Pastel / Georgian

Tate

If you're looking to bring natural light into your home, choose the Tate design to bring the outdoors in.

Walton

Classic in appearance whilst offering a high level of privacy, the Walton is the ideal choice for style conscious homeowners who live in urban areas.



Pearl Grey / Sarah



Duck Egg / Elegance



Elephant Grey / Comete



Chartwell Green / Spring

Wentwood

Combine the Wentwood door style with any of our triple glazed glass designs to create a real style statement.



Cream / Fabian



Duck Egg / Riviera



French Navy / Opus



Raven Black / Fabian



Rich Red / Riviera

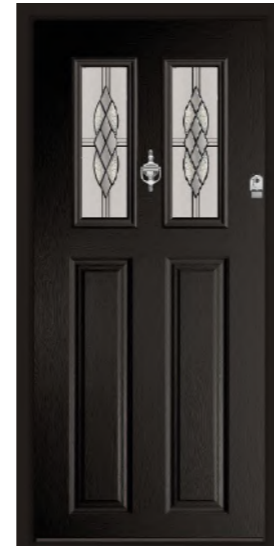

Schwarz Braun / Graphite



French Navy / Sarah



Pearl Grey / Graphite



Rich Red / Comete



Turquoise Pastel / Harmony

Get The Look: Classic & Captivating



Classic & Captivating

A timeless look that will always be the height of sophistication. Traditional styling is carefully considered, with every element of your entrance chosen to work in harmony.

TOP TIP:

Complement any of our muted pastel colours with brightly coloured flowers to give your entrance instant impact.

Going Grey Never Looked So Good

Give your entrance a contemporary edge by opting for a Pearl Grey finish. The pastel tone of Pearl Grey will give your entrance a sophisticated and luxurious appeal.

Let the Light In

One of our most popular glazing styles, Riviera is a beautiful triple glazed design with a combination of bevels, lead and textured glass. Fill your hallway with natural light whilst still maintaining your privacy with this classic design.



Complete The Look

Graphite accessories complement the pastel hue of the Pearl Grey door colour. The traditional Urn Knocker is a popular choice alongside any of our Classic Door Styles, whilst the Heritage Finger Pull really completes the Traditional Look.



Who lives here?

Showcase your individual style by accessorizing your entrance. Simple styling of your entrance way can make the difference between having a nice door or creating a beautiful entrance to your home.



View our Classic & Captivating Style Guide online. Scan this code with the camera on your Smartphone to get inspired now.

The Country Collection



Antique Black hardware is the ideal way to bring a handcrafted appearance to your door from the Country Collection. The textured surface of the hardware gives it an industrial quality that really complements the authentic woodgrain effect of an Endurance Door.

The Country Collection

Our Country Collection features a range of traditional shiplap styles that look fantastic in earthy tones such as Pebble or any of our woodgrain finishes. These designs are ideal for bringing a charming, heritage feel to your home.



Abbot
pg.40



Algas
pg.41



Brecon
pg.42



Bredon
pg.43



Cleeve
pg.44



Coombe
pg.45



Eldon
pg.46



Esk
pg.47



Gibson
pg.48



Hallin
pg.49



Kentmere
pg.50



Kit
pg.51



Knott
pg.52



Lingmoor
pg.53



Malvern
pg.54



Mardale
pg.55



Rushmore
pg.56



Sanford
pg.57



Stanley
pg.58



Starling
pg.59



Tove
pg.60



Tyree
pg.61

Abbott

A contemporary twist on country style. The Abbott's shiplap detailing gives this style a real traditional, handmade appearance.



Irish Oak / Opal



Anthracite Grey / Fabian



Duck Egg / Spring



Pearl Grey / Riviera



Racing Green / Harmony



Rosewood / Bullion



Schwarz Braun / Comete



Elephant Grey / Comete



Chartwell Green / Elegance



Anthracite Grey / Opal



French Navy / Riviera



Golden Oak / Elizabeth Red



Schwarz Braun / Harmony



Walnut / Virtue

Algas

One of the more eye catching designs in the Country Collection. The Algas' generous glazed area can be used to really make a style statement.

Brecon

Inspired by the timber doors often found on quaint cottages, the Brecon offers privacy and a cosy feeling for the inside of your home.



French Navy



Elephant Grey



Duck Egg



Irish Oak



Chartwell Green



Anthracite Grey



Irish Oak



Pebble



Racing Green



Turquoise Pastel



Pearl Grey



Pebble



Walnut



White

Bredon

Channel rural charm with a solid and secure Bredon door with its authentic timber appearance and simplistic design.

Cleeve

The diamond glazing of the Cleeve will really make your entrance pop. Choose Bullion glass to maintain your privacy whilst still letting in lots of light.



Chartwell Green / Bullion



Duck Egg / Bullion



Elephant Grey / Satin



Elephant Grey / Iris



Cream / Opus



Duck Egg / Diamonte



Irish Oak / Satin



Pearl Grey / Bullion



Pebble / Bullion



Turquoise Pastel / Bullion



Chartwell Green / Gracia Green



Golden Oak / Sarah



Irish Oak / Spring



Walnut / Fabian

Coombe

One of our most popular designs. The centralised glazing of the Coombe design is compatible with almost our full glazing range.

Eldon

Fill your hallway with natural light, thanks to the generous diamond glazing of this design. Opt for Bullion or Satin glass to maintain your privacy.



Anthracite Grey / Clear



Chartwell Green / Bullion



Cream / Bullion



Golden Oak / Opus



Duck Egg / Opal



Chartwell Green / Riviera



Elephant Grey / Bullion



Golden Oak / Bullion



Turquoise Pastel / Bullion



Walnut / Bullion



Irish Oak / Virtue



Pebble / Sarah



Racing Green / Comete



Walnut / Murano Green

Esk

Get creative with the Esk. This design is equally at home on a traditional country cottage or a more modern, contemporary property.

Gibson

The offset diamond glazing gives the Gibson style a distinctive and eye catching appearance.



Chartwell Green / Satin



Duck Egg / Bullion



Elephant Grey / Bullion



Golden Oak / Opal



Chartwell Green / Riviera



Duck Egg / Sarah



Golden Oak / Bullion



Irish Oak / Bullion



Rich Red / Bullion



Rosewood / Bullion



Elephant Grey / Comete



Anthracite Grey / Spring



Pebble / Virtue



Schwarz Braun / Harmony

Hallin

Privacy, Security and Style. The Hallin is the ideal choice for adding rural charm to your entrance.



Chartwell Green / Riviera



Duck Egg / Sarah



Elephant Grey / Comete



Anthracite Grey / Spring



Pebble / Virtue



Schwarz Braun / Harmony

Kentmere

A traditional Shiplap design with stylish diamond glazing. The Kentmere looks equally stunning in any of our woodgrain or more vibrant colour choices.



Anthracite Grey / Clear



Chartwell Green / Bullion



Duck Egg / Bullion



Golden Oak / Fabian



Chartwell Green / Riviera



Duck Egg / Spring



Pearl Grey / Bullion



French Navy / Bullion



Walnut / Clear



Rich Red / Bullion



Anthracite Grey / Opal



Irish Oak / Clarence



Pearl Grey / Virtue



Schwarz Braun / Harmony

Kit

One of the more contemporary styles from the Country Collection. The Kit can be styled to look equally at home on a rural or more modern property.

Knott

Complete the charming rural appearance of your home with the Knott. Bull ring knockers look fabulous on this solid and secure design.



Cream / Harmony



Chartwell Green / Harmony

Lingmoor

Combining an authentic timber appearance and a generous glazed area, the Lingmoor will allow natural light to fill your home.



Anthracite Grey / Riviera



Chartwell Green / Spring



Cream / Katrina



Duck Egg / Sarah



Duck Egg / Sarah



French Navy / Diamonte



Irish Oak / Bullion



Racing Green / Opus



Elephant Grey / Graphite



Golden Oak / Comete



Irish Oak / Spring



Walnut / Linear

Malvern

Chartwell Green and Duck Egg are popular choices for the Malvern style. Choose a complementing letter plate and lever pad handle to complete the look.



Chartwell Green / Spring



Duck Egg / Harmony



Golden Oak / Riviera



Anthracite Grey



Chartwell Green



Cream

Mardale

For the authentic shiplap timber look, opt for the Mardale. This solid design will keep your home safe and secure and feeling cosy on the inside.



Elephant Grey / Sarah



Irish Oak / Virtue



Pebble / Fabian



Racing Green / Clarence



Duck Egg



Golden Oak



Turquoise Pastel



Walnut

Rushmore

A popular choice for back doors, or front doors in private locations. The Rushmore can be also ordered as a stable door and with Georgian glazing bars.



Cream / Clarence



Anthracite Grey / Comete

Sanford

A large glazed area means your Sanford door will let in lots of natural light. Maintain your privacy with our range of stylish triple glazed and sandblasted glass designs.



Anthracite Grey / Georgian



Chartwell Green / Harmony



Chartwell Green / Linear



Cream / Adina



Duck Egg / Georgian



Pearl Grey / Deco



Racing Green / Riviera



Turquoise Pastel / Sarah



Duck Egg / Fabian



Elephant Grey / Graphite



Irish Oak / Georgian



Pearl Grey / Harmony

Stanley

The modest glazed panel of the Stanley will let a little natural light into your home and allow you to see visitors before opening your door.



Turquoise Pastel / Sarah



Chartwell Green / Bullion

Starling

Diamond glazing adds a little flair to this traditional shiplap design. Combine the Starling with Heritage hardware to really complete the look.



Anthracite Grey / Harmony



Chartwell Green / Spring



Cream / Bullion



Duck Egg / Bullion



Duck Egg / Riviera



Elephant Grey / Clarence



Pearl Grey / Virtue



Cream / Opal



Golden Oak / Bullion



Irish Oak / Satin



Pearl Grey / Bullion



Walnut / Bullion

Tove

Choose the Tove to add instant kerb appeal to your home. Our range of glazing options means you can find a balance between letting in light and maintaining your privacy.



Walnut / Clarence



Anthracite Grey / Sarah



Chartwell Green / Opus



Chartwell Green / Spring



Cream / Clarence



Duck Egg / Riviera



Duck Egg / Graphite



Irish Oak / Riviera



Pearl Grey / Spring



Cream / Comete



Elephant Grey / Comete

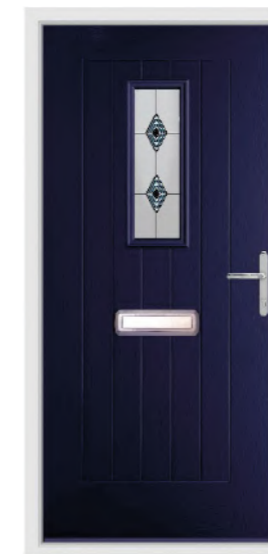

French Navy / Diamonte



Golden Oak / Opus



Irish Oak / Opal

Tyree

A Heritage Finger Pull really sets off this design, maintaining it's rural appearance and giving a sense of simplicity from years gone by.

Get The Look: Industrial Vintage



Industrial Vintage

Industrial Vintage is about proudly displaying the building materials that many try to conceal. It's about adding a raw, unfinished look to the most thoughtfully designed entrances.

Wood + Metal: A Match Made In Heaven

The authentic timber detailing of an Endurance Door, coupled with the shiplap style of the Rushmore Georgian gives this door a raw and handmade feel. Choose Anthracite Grey to add cool metallic vibes and continue the Industrial theme.

Less Can be More

Far from boring, clear Ornate glazing has been chosen to offer a simplistic, no nonsense look to this entrance. Opting for clear glazing has also enabled this homeowner to add an extra layer of styling in the form of a decorative interior blind.



Experiment with Colour

Whilst a pared back colour palette is key to achieving an Industrial Look, you can experiment with adding in carefully considered colours to add a little intrigue to your entrance. Here, the homeowner has chosen to use plants to add in splashes of colour to great effect.



View our Industrial Vintage style Guide online. Scan this code with the camera on your Smartphone to get inspired now.

TOP TIP:

One of the key elements to achieving an industrial look is the use of texture. Here, timber cladding, galvanized steel milk pails, terracotta pots and a woven interior blind complement each other, adding a variety of different textures and materials to complete the look.



The *Urban* Collection



The styles within our Urban Collection are characterized by their intentional symmetry. Combine these styles with any of our Grey or Black colours and a simplistic glazing design for an ultra-modern appearance.

The *Urban* Collection

Lift your home into the 21st century with a contemporary door design from our Urban Collection. These doors feature clean lines and minimalistic styling to create an entrance that is both sleek and sophisticated. Complete the look by opting for a stainless steel pull handle from our range of Hardware Accessories.



Alto
pg.66



Antero
pg.67



Bleaklow
pg.68



Calva
pg.69



Fuji
pg.70



Grasmoor
pg.71



Ketu
pg.72



Kuppe
pg.73



Kyo
pg.74



May
pg.75



Mayon
pg.76



Pen
pg.77

Alto

One of our most popular designs. The Alto looks truly stunning in any of our Grey or Black colour options. Combine with a pull bar handle to really complete the Urban look.



Elephant Grey / Comete



Cream / Satin

Antero

Our most recent addition to the Endurance Doors range, the Antero's triple diamond glazing is the ultimate style statement.



Anthracite Grey / Iris



Duck Egg / Riviera



Duck Egg / Bullion



Elephant Grey / Satin



French Navy / Comete



Pearl Grey / Virtue



Pebble / Fabian



Schwarz Braun / Virtue



Golden Oak / Satin



Pearl Grey / Satin



Racing Green / Bullion



Schwarz Braun / Bullion

Bleaklow

The tall glazed area is a real feature of the Bleaklow design. Choose Satin glass to maintain your Privacy or opt for Clear to let in even more natural light.



Walnut / Satin



Anthracite Grey / Satin



Elephant Grey / Clear



Irish Oak / Satin



Pebble / Satin



Raven Black / Satin



French Navy / Satin



Anthracite Grey / Murano Black



Duck Egg / Diamonte



Elephant Grey / Clarence



French Navy / Riviera



Pebble / Harmony



Racing Green / Bullion



Schwarz Braun / Virtue

Calva

The offset glazing of this design gives the Calva a distinctly Urban feel, whilst the shiplap style finishing acts as a nod to the traditional timber door design.

Fuji

Long Pull Bar Handles and our range of Greys are extremely popular with the Fuji design. Bring the front of your home into the 21st Century with this ultra modern style.



Elephant Grey / Comete



Anthracite Grey / Virtue



Duck Egg / Joy



Anthracite Grey

Grasmoor

Sometimes, less is more. Opt to keep things sleek and simple with a single Pull Bar Handle.



Duck Egg



Elephant Grey



Pearl Grey / Riviera



Rosewood / Harmony



Schwarz Braun / Graphite



White / Fabian



Golden Oak



Pearl Grey



Raven Black



Schwarz Braun

Ketu

Tall glazed area, long Pull Bar Handle. This stylish design will bring an ultra-modern look to your home's exterior whilst still offering an industrial quality thanks to the shiplap finishing.



Golden Oak / Satin



Anthracite Grey / Satin



Duck Egg / Clear



Irish Oak / Satin



Pearl Grey / Clear



Schwarz Braun / Clear



Walnut / Satin



Anthracite Grey / Iris



Cream / Linear



Elephant Grey / Deco



Golden Oak / Adina



Pearl Grey / Graphite



Raven Black / Opal



Schwarz Braun / Virtue

Kuppe

Sleek and stylish. The Kuppe design is compatible with nearly our full range of glazing options. Choose a simplistic glazing design to complete the look.

Kyo

The choice for an ultra-modern entrance. The Kyo's Art Deco inspired glazing will give the exterior of your home a truly unique appearance.



Pebble / Fabian



Anthracite Grey / Murano Black



Duck Egg / Opal



Duck Egg / Satin



Elephant Grey / Clear



French Navy / Satin

May

Bring the outside in with the May. With its nearly full-length glazing, natural light is guaranteed to fill your home. Choose Satin glass to maintain your privacy.



Rosewood / Clarence



Pearl Grey / Brilliance



Raven Black / Harmony



Turquoise Pastel / Comete



Golden Oak / Clear



Raven Black / Clear



Schwarz Braun / Clear



Walnut / Satin

Mayon

Totally solid. The Mayon design is the cornerstone of our Urban collection and one of our most popular designs.



Anthracite Grey



Duck Egg



Elephant Grey



Anthracite Grey / Satin



Chartwell Green / Satin



Duck Egg / Clear



Mayon



Pearl Grey



Pebble



Schwarz Braun



Elephant Grey / Satin



Mahogany / Satin



Pearl Grey / Clear



Raven Black / Clear

Pen

Choose the Pen in any of our Grey or Black colours to create an entrance that is both sleek and stylish. Combine with a modern Pull Bar Handle to complete the look.

Get The Look: Urban Luxe

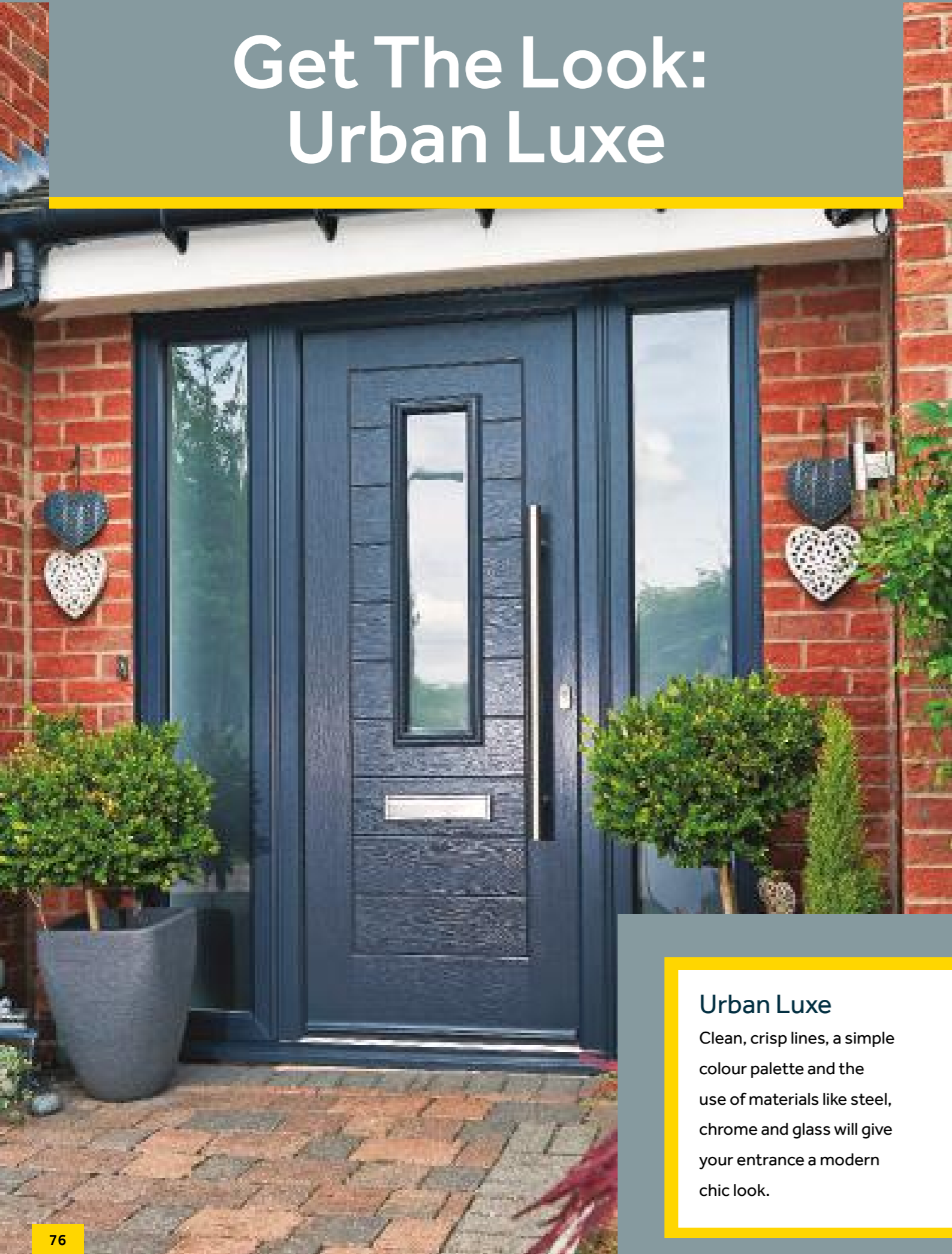

Urban Luxe

Clean, crisp lines, a simple colour palette and the use of materials like steel, chrome and glass will give your entrance a modern chic look.

Simple Styling

Straight lines and stylish detailing are key features of the Alto Design. Coupled with one of our Grey or Black colours, this style is sure to add instant kerb-appeal to any home that leans towards a more modern appearance.

Urban Steel

Continue the simple styling of your entrance with a Stainless-Steel Pull Handle. Available in a variety of lengths, opt to make a style statement with a long pull handle or choose functional and understated with a smaller size.



Keep your Privacy

Wanting to maintain your privacy whilst still having a light and airy hallway? Choose Satin glass to enjoy the best of both worlds.



Complete the Look

For a seamless look, match the colour of your windows and garage door to the colour of your stylish new Endurance Door. All of our Grey colours are readily available from other suppliers who manufacture both windows and garage doors.



View our Urban Style Guide online. Scan this code with the camera on your Smartphone to get inspired now.

Double Doors

Give your entrance instant wow-factor with a set of solid and secure double doors from Endurance. Our double doors are available in an extensive range of styles and finishes, and to offer versatility an offset double door is available too.

Our full range of double door designs are available to view on our HomeView Door Designer at endurancedoors.co.uk

endurancedoors.co.uk

Double Door Dimensions

Minimum & Maximum Widths for Double Doors

Double Doors:
1598mm min
1968mm max

Off Set Double Doors:
1252mm min
1512mm max



Pen



Tyree



May



Alto



Stable Doors



Open up the inside of your home with our range of stable door designs. Suitable as both a front and back door, our extensive range of styles and colours are the ideal way to add a personal touch to your home.

Endurance stable doors come with two completely separate locks, with a high strength centre gear box, a handle operated top lock and a key/thumb turn operated bottom lock. These locks come keyed alike, meaning both locks can be opened with a single key.

- ✓ The key operated bottom lock escutcheon is available in a variety of finishes.
- ✓ The internal centre locking bolt is available in gold and chrome finishes.



Malvern



Mardale



Rushmore



Sanford

Our full range of Stable door designs are available to view on our HomeView Door Designer

endurancedoors.co.uk



The Endurance stable door range is available for opening in doors only.

Side Panels and Toplights



Create a sense of grandeur to your home with our range of stunning side panels, lights and toplights.

Opt to fill your home with natural light with a fully glazed side or toplight or complement your chosen Endurance door design with a perfectly matching side panel.

Our full range of side panels, lights and toplights are available to view on our HomeView Door Designer at endurancedoors.co.uk.

endurancedoors.co.uk



Alto



Tyree



Etna



Monte Viso



Visualise your dream entrance and view our full range of sidelights and panels on our HomeView Door Designer at

endurancedoors.co.uk



Eye Catching Glazing



Whether you're looking to create a light and airy hallway or a private entrance, our range of glazing options make it easy to achieve your desired look and feel.

All of our glass designs have been thermally toughened, resulting in a glazing range that is both strong and secure as well as stylish.

Fabian Triple Glazed

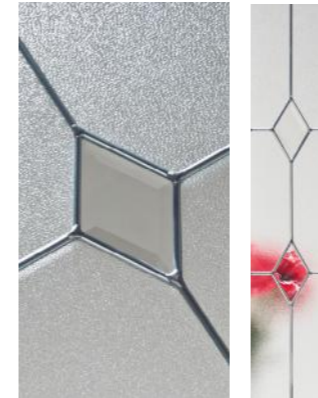

OBSCURITY



Bowmont



Scafell



Kit



Wentwood

Clarence Triple Glazed



OBSCURITY



Bowmont



Eiger



Hallin



Lingmell

Riviera Triple Glazed



OBSCURITY



Bowmont



Fuji



Malvern



Tate

Eye Catching Glazing

Comete



OBSCURITY



Alto



Cheviot



Etna



Kit

Katrina



OBSCURITY



Coombe



Etna



Lingmoor



Monte Rosa

Deco

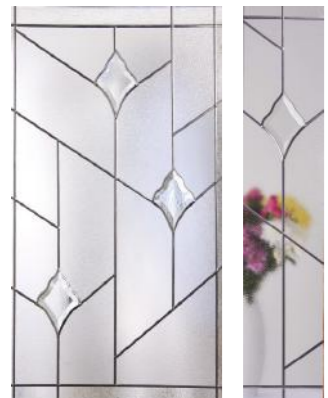

OBSCURITY



Etna



Kuppe



Monte Rosa



Snowdon

Linear



OBSCURITY



Coombe



Kuppe



Lingmoor



Snowdon

Elegance



OBSCURITY



Algas



Cheviot



Etna



Tyree

Brilliance



OBSCURITY



Cheviot



Eiger



Olympus



Rushmore

Eye Catching Glazing

Opal



OBSCURITY



Algas



Bowmont



Hallin



Sanford

Graphite

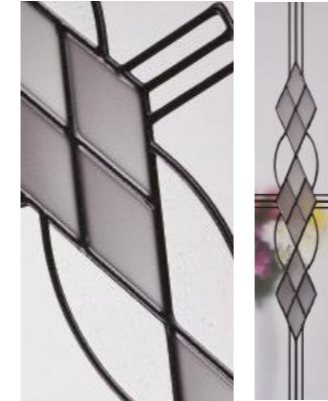

OBSCURITY



Coombe



Bowmont



Fuji



Rushmore

Elizabeth

Colours Available: Red, Blue



OBSCURITY



Berwyn



Cheviot



Hope



Walton

Spring

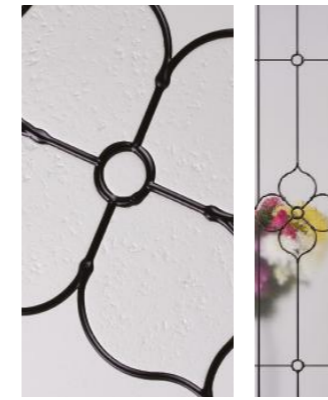

OBSCURITY



Abbott



Hope



Olympus



Tove

Opus



OBSCURITY



Bowmont



Hallin



Hope



Lingmoor

Harmony

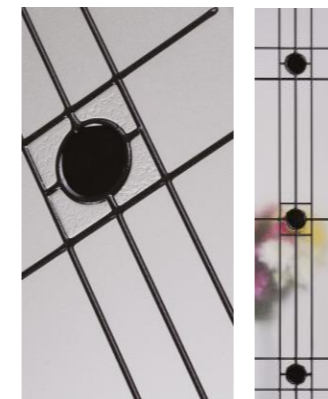

OBSCURITY



Etna



Lingmoor



Olympus



Rushmore

Eye Catching Glazing

Diamonte

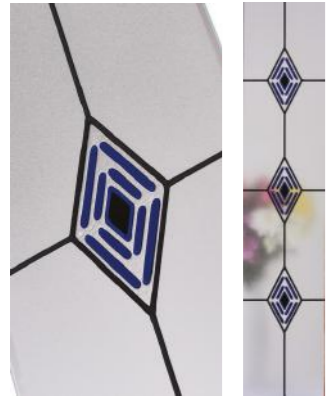

OBSCURITY



Bowmont



Cheviot



Olympus



Snowdon

Sarah



OBSCURITY



Wentwood



Etna



Hallin



Cheviot

Adina

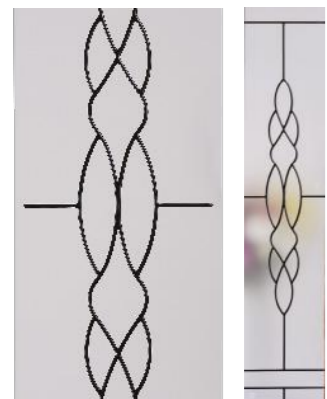

OBSCURITY



Coombe



Etna



Olympus



Rushmore

Gracia

Colours Available: Green, Blue, Clear



OBSCURITY



Coombe



Etna



Lingmoor



Monte Rosa

Virtue



OBSCURITY



Alto



Cheviot



Etna



Mont Blanc

Iris



OBSCURITY



Alto



Etna



Kuppe



Lingmoor

Eye Catching Glazing

Gavalas

Colours Available: Blue, Green, Clear



OBSCURITY



Elbrus



Etna



Kit



Kyo

Kerner



OBSCURITY



Etna



Lingmoor



Monte Rosa



Scafell

Joy



OBSCURITY



Fuji



Fuji



Scafell



Scafell

Satin

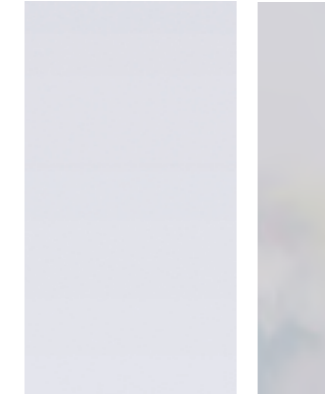

OBSCURITY



Monte Rosa



Scafell

Clear



OBSCURITY



Snowdon Georgian

Murano



OBSCURITY



Bowmont



Hope



Olympus



Rushmore

Bullion



Starling

View our full range of glazing styles on our HomeView Door Designer.

We have over 60 designs for you to choose from.

endurancedoors.co.uk

Glazing Matrix

Use our Glazing Matrixes to see if your chosen Endurance Door design is available with your favourite Glazing Style.

Classic Collection

Door Style	Glazing Style	Berwyn	Bowmont	Cheviot	Eiger	Elbrus	Etna	Hope	Lingmell	Mont Blanc	Monte Rosa	Olympus	Pentland	Scafell	Skiddaw	Snowdon	Tate	Walton	Wentwood
Adina							X				X	X				X	X		
Brilliance				X	X		X				X	X				X	X		
Bullion										X									
Clarence		X	X	X	X	X	X	X	X	X	X			X	X	X	X	X	X
Comete		X	X	X	X	X	X	X	X	X	X			X	X	X	X	X	X
Deco							X				X					X	X		
Diamonte			X	X	X	X	X			X	X	X			X	X	X	X	
Elegance			X	X	X	X	X			X	X	X			X	X	X	X	
Elizabeth		X	X	X	X	X	X	X		X	X				X			X	
Fabian		X	X	X	X	X	X	X	X	X	X			X	X	X	X	X	X
Gavalas			X	X	X	X	X			X	X				X			X	
Georgian				X									X			X	X		
Gracia							X				X					X	X		
Graphite			X	X	X	X	X			X	X	X		X	X	X	X	X	X
Harmony			X	X	X	X	X		X	X	X	X		X	X	X	X	X	X
Iris							X				X								
Joy														X					
Katrina							X				X								
Kerner							X				X			X					
Linear							X				X					X	X		
Murano		X	X	X	X	X	X			X	X	X			X	X	X	X	
Opal			X	X	X	X	X			X	X	X			X	X	X	X	
Opus		X	X			X	X	X		X	X							X	
Clear		X	X	X	X	X	X	X	X	X	X	X	X	X	X	X	X	X	X
Riviera			X	X	X	X	X		X	X	X			X	X	X	X	X	X
Sarah		X	X	X	X	X	X	X		X	X	X		X	X	X	X	X	X
Satin		X	X	X	X	X	X	X	X	X	X	X	X	X	X	X	X	X	X
Spring		X	X	X	X	X	X	X	X	X	X	X		X	X	X	X	X	X
Virtue		X	X	X	X	X	X	X		X	X			X	X	X	X	X	

Country Collection

Door Style	Glazing Style	Abbott	Algas	Cleeve	Coombe	Eldon	Esk	Gibson	Hallin	Kentmere	Kit	Knott	Lingmoor	Malvern	Rushmore	Sanford	Stanley	Starling	Tove	Tyree
Adina					X								X		X	X				
Brilliance					X								X		X	X				
Bullion		X		X		X		X	X	X		X			X		X	X		
Clarence		X	X		X	X		X		X	X	X	X	X	X	X	X		X	X
Comete		X	X		X	X		X		X	X	X	X	X		X	X		X	X
Deco					X								X		X	X				
Diamonte		X	X		X	X		X		X	X	X	X	X	X	X	X		X	X
Elegance		X	X		X	X		X		X	X	X	X	X	X	X	X		X	X
Elizabeth		X	X		X	X		X		X	X	X	X	X			X		X	X
Fabian		X	X		X	X		X		X	X	X	X	X	X	X	X		X	X
Gavalas		X	X		X	X		X		X	X	X	X	X			X		X	X
Georgian															X	X				
Gracia					X								X		X	X				
Graphite		X	X		X	X		X		X	X	X	X	X	X	X	X		X	X
Harmony		X	X		X	X		X		X	X	X	X	X	X	X	X		X	X
Iris					X								X							
Katrina					X								X							
Kerner					X								X							
Linear					X								X		X	X				
Murano		X	X		X	X		X		X	X	X	X	X	X	X	X		X	X
Opal		X	X		X	X		X		X	X	X	X	X	X	X	X		X	X
Opus		X	X		X	X		X		X	X	X	X	X			X		X	X
Clear		X	X	X	X	X	X	X	X	X	X	X	X	X	X	X	X	X	X	X
Riviera		X	X		X	X		X		X	X	X	X	X	X	X	X		X	X
Sarah		X	X		X	X		X		X	X	X	X	X	X	X	X		X	X
Satin		X	X	X	X	X	X	X	X	X	X	X	X	X	X	X	X	X	X	X
Spring		X	X		X	X		X		X	X	X	X	X	X	X	X		X	X
Virtue		X	X		X	X		X		X	X	X	X	X	X	X	X		X	X

Glazing Matrix

Hardware Accessories

Urban Collection

Door Style	Glazing Style	Alto	Antero	Bleaklow	Calva	Fuji	Ketu	Kuppe	Kyo	May	Pen
Adina		x						x			
Brilliance		x						x	x		
Bullion			x		x						
Clarence		x			x	x		x	x		
Comete		x			x	x		x	x		
Deco		x						x			
Diamonte		x			x			x	x		
Elegance		x			x			x	x		
Elizabeth		x			x			x	x		
Fabian		x			x	x		x	x		
Gavalas		x			x			x	x		
Georgian									x		
Gracia		x						x			
Graphite					x	x		x	x		
Harmony		x			x	x		x	x		
Iris		x						x			
Joy						x					
Katrina		x						x			
Kerner		x				x		x			
Linear		x						x			
Murano		x			x			x	x		
Opal		x			x			x	x		
Opus		x			x			x			
Clear		x	x	x	x	x	x	x	x	x	x
Riviera		x			x	x		x	x		
Sarah		x			x	x		x	x		
Satin		x	x	x	x	x	x	x	x	x	x
Spring		x			x	x		x	x		
Virtue		x			x	x		x	x		



Even though hardware accessories are the last thing to be fitted to your door, they are certainly the element which draws the most attention. It's the part of the door we touch and use the most, and can be a real indicator of overall quality.

HANDLES



Windsor Lever
Lever Handle



Windsor Lever
Pad Handle



Pull Knob



Escutcheon

LETTERPLATE



This high security, fully weather sealed letterplate has an anti-snap flap making it both stylish and secure.

Fully colour matched with the other items in the Classic range, it's the ideal finishing touch for an aesthetically pleasing door.

Choose this letterplate for Secured by Design accreditation (letterplate cowl supplied loose and not pictured).

AVAILABLE COLOURS

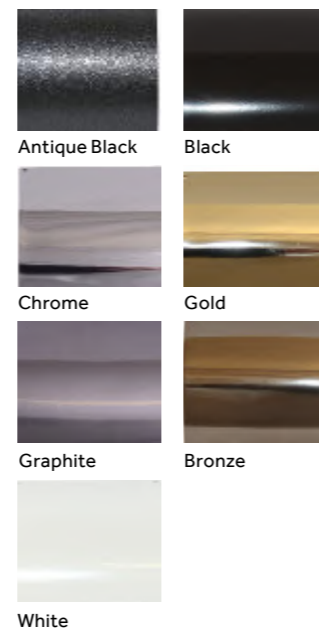

KNOCKERS



Urn Knocker



Spy Urn
Knocker



Slimline Urn
Knocker



Spy Slimline
Urn Knocker



When selecting items of hardware from different ranges, please be aware that there may be slight variations in colour and finish.

HANDLES



Heritage Lever
Lever Handle



Heritage Lever
Pad Handle



Pull Knob



Finger pull set

LETTERPLATE



This beautifully designed letterplate suits a whole host of different door designs and is colour matched with the other items in the Heritage range.

The anti-snap flap opens to 180 degrees ensuring it's easy to use, meets Royal Mail standards and is both weather sealed and completely secure.

Not Secured by Design

AVAILABLE COLOURS

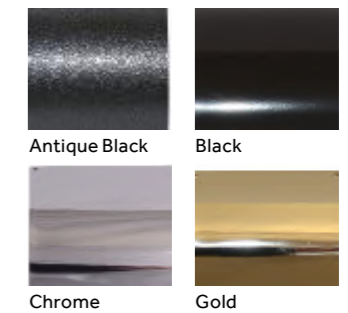

BULLRING KNOCKER

The Heritage bullring knocker is the final finishing touch to an elegant front door, and has the feel of durability and quality.



Antique Black hardware can differ between items in terms of its finish due to the handcrafted nature of the product.

HANDLES



This modern lever handle is ideal for contemporary doors, with a perfectly matching letterplate and knocker. The ergonomically designed handle is easy to grip and operate, plus it looks great too.



Architectural Lever Handle

LETTERPLATE



This stylish letterplate is sure to complement the most modern door styles, and its anti-snap flap opens to 180 degrees to give clear access for A4 mailings.

AVAILABLE COLOURS

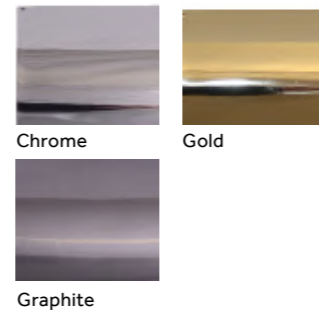

Chrome

Gold

Graphite

KNOCKER

Simple yet stunning, the Architectural knocker adds the perfect finishing touch to your new door.



When selecting items of hardware from different ranges, please be aware that there may be slight variations in colour and finish.



STAINLESS STEEL PULL HANDLES

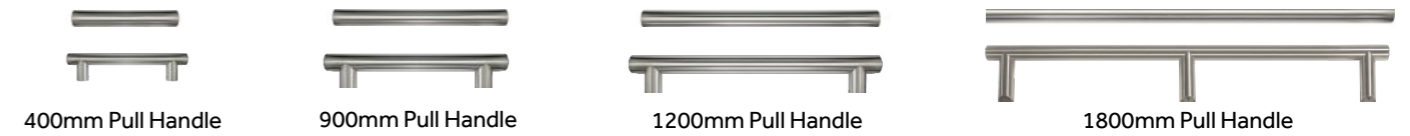

Stainless steel pull handles can add the perfect finishing touch to your modern Endurance Door.

Available in 4 different sizes and supplied with a matching internal pull knob and escutcheon, they are a great choice for style-conscious homeowners.

There's also an offset pull handle available – please contact your installer for more details.



Pull Knob

Escutcheon

COMPLEMENTING HARDWARE



Whilst we do not offer a fully suited range of Urban hardware, we recommend choosing a Graphite letterplate and knocker from our Architectural range to complement your pull bar.



When selecting items of hardware from different ranges, please be aware that there may be slight variations in colour and finish.

Endurance Smart Tech

ULTION SMART

Enjoy the convenience and peace of mind that Ultion Smart brings.

This innovative new locking mechanism can be used to automatically lock, unlock and even open your Endurance Door when you leave or arrive at home.

Combined with the 3 Star High Security Ultion Locking Cylinder, the Ultion Smart offers both cutting edge technology and unrivalled security for your home.



Also available as an escutcheon only version

endurancedoors.co.uk

Handsfree Operation

Unlike other Smart locks available on the market, the Ultion Smart offers truly handsfree operation. No more fumbling around for keys in the rain and no more frantically looking for your keys before leaving home.

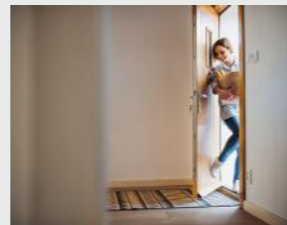

Auto Unlock

You can set Ultion Smart to unlock as soon as you enter your designated unlock zone, without even touching your phone.



Auto Lock

Never wonder if you locked the door again. You can set how long Ultion Smart stays unlocked for before securing itself again.*

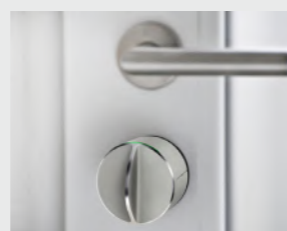

Auto Open

Use this feature to set how long the latch stays open for whenever the door is unlocked. Then simply push your Endurance door open.

4 Easy Ways to Use Ultion Smart.

Your fully customisable Ultion Smart Lock can be controlled and operated in a variety of ways. Depending on which version you buy, the your Ultion Smart can be operated by:



Amazon Alexa

Control your Ultion Smart by simply saying "Alexa, lock the door"



Apple Homekit

The Apple Homekit version enables you to control Ultion Smart with Siri, iPhone, iPad or even Apple watch.



Bluetooth

The free and simple to use Danalock app brings all the functions together with no need for anything else.



Key

Every version of Ultion Smart comes with the ability to lock and unlock in the traditional way. A key.

Extra Benefits



Great Battery Life

Just 4x CR123 easy-to-change batteries provides an expected 1.5 years of usage. You can even keep track of battery life via the app.



Powerful 12v Motor

The Ultion Smart 12v motor generates 1.5Nm of torque to ensure a secure and smooth operation on demand.



Send Remote Keys

Not at home and need to let someone in? No problem, the Bluetooth & Alexa versions let you send a digital key for temporary access.



Voice Controlled

Control Ultion Smart by asking Alexa or Siri for hands-free and phone-free locking.



Customisable Settings

Control everything from auto-unlock proximity range to lock timings with our free app, available on our Bluetooth & Alexa versions.



Access can be given, removed and monitored using the integration within the AirBnB app.

Flexible Looks

Your Ultion Smart is available in your choice of colours and can even be combined with any of our external Lever / Lever handles for a seamless exterior appearance.

The Ultion Smart colour options do not perfectly match the rest of our hardware range.

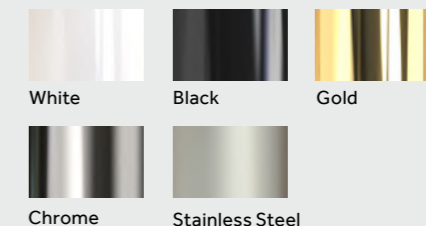

*Doors fitted with a Trulock+ require the lever to have been lifted for this function

Threshold Options

We offer a threshold to suit every homeowner. The MDS25 and Macclex Aluminium Thresholds are both Part M Compliant and meet the latest regulations for Building Regulations for Easy Access.

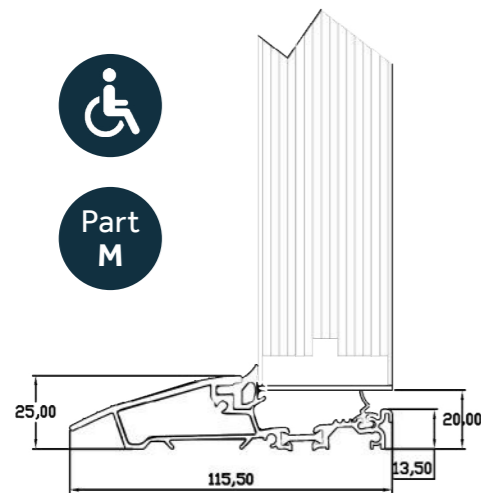

MDS25

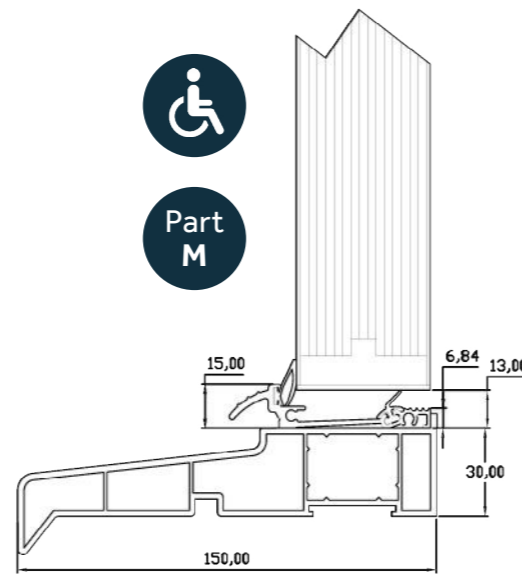

Macclex

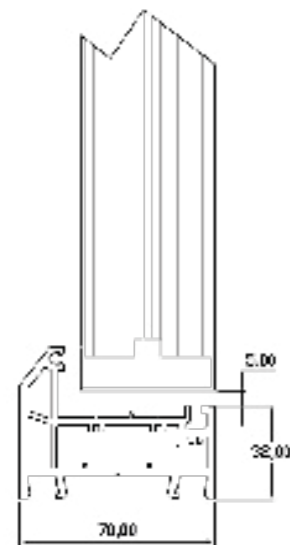

52mm PVC

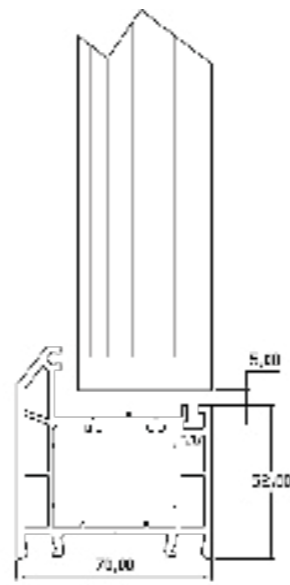

72mm PVC

Our standards



Environmental concerns and energy efficiency are core to our company ethos. We appreciate the need to act responsibly, but at the same time offer our customers new advances that 'thinking green' has to offer.

Our accreditations:

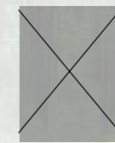

1. We've reviewed our work systems and wherever possible minimised our waste and energy.

2. We manage an extensive recycling programme which covers packaging, polystyrene, cardboard, PVC-u, timber, paper, aluminium and steel.

3. All of the timbers used in our doors are harvested from forests which are managed to meet the social, economic and ecological needs of present and future generations.

4. The laminated veneer core is fully environmentally accredited which includes PEFC and full BM Trada 'Chain of Custody'. Chain of Custody certification outlines the requirements for tracking certified materials from the forest to the final product to ensure that the wood contained in the product originates from certified forest.

5. Renewable and recyclable, Kerto is a highly eco-effective door core material, throughout its life cycle. The timber is sustainably managed PEFC/FSC – certified from Finnish forests. PEFC and FSC certification ensures that the entire

forest supply chain promotes good practice in the forest and ensures that timber products are produced with respect for the highest ecological, social and ethical standards. This includes protection of indigenous people's rights to the methods of felling trees.

6. Our transport department have reviewed their schedules to ensure that deliveries are made in the most fuel conscious manner possible, whilst preserving our assurances on delivery times.

7. The vehicles we use have a heritage of fuel economy; low-rolling-resistance tyres, start/stop, cruise control and energy recuperation. Working together, they create instant fuel savings and lower emissions.

8. In the manufacture of Endurance doors we aim to source thermoplastic components and materials that contain lead-free stabilisers which are better for the environment.

9. The 5 chamber door outer frame PVCu profile has been specifically designed for thermal efficiency and is calcium organic using lead free stabilisers.

Endurance Doors are tested to:

BS EN ISO 10077-1:2006

Classification for thermal performance of doors

BS 6375-1:2009

Classification for weather tightness

PAS24:2016

Classification for enhanced security for key/key operation

BS 6375-2:2009

Classification for operation and strength characteristics

PAS24:2016

Classification for enhanced security for key/thumb turn operation

ENDURANCE[®]

Solid & Secure Composite Doors



All colours and images are a visual representation only. We recommend you request to see colour samples from your chosen Preferred Installer. Slight variations in colours and finish may occur due to the handcrafted nature of the product or the limitations of the printing process. As it is company policy to improve products and materials, changes to specification may be made from time to time without prior notice.